



KEY-LINK[™]
FENCING & RAILING

ALUMINUM RAILING





RAILING SHOULD NEVER BE AN AFTERTHOUGHT

Railing is the first thing you see when you step onto your deck, it's essential for safety, and it literally surrounds you at every turn. Choose railing that sets the tone and matches the quality you want in the rest of your outdoor living space.

Key-Link aluminum railing is the premier choice for both residential and commercial spaces. Contractors and builders praise Key-Link's quality and the thoughtful details that make it easy to install. Home and business owners love Key-Link's unique design and premium craftsmanship.



Manufactured in the USA

Key-Link's products are proudly designed and manufactured in the USA to ensure a quality fit and finish.

WHAT IS KEY-LINK QUALITY?

- AAMA 2604 standard powder coating on railing and accessories to promote weatherability, with AAMA 2605 standard available for additional protection
- IBC or IRC code compliance for peace of mind and safety
- High-quality aluminum with vinyl inserts to hold balusters snugly and prevent rattling
- Limited lifetime warranty and 5-year prorated labor warranty



Contents

American Series	4-7
Outlook Series	8-11
Chesapeake Series	12-15
Railing Overview	16
External Cable Fittings.....	17
Brackets	18-19
Placid Point Lighting.....	20-21
Post Caps, Trim.....	22
Posts, Porch Posts.....	22
ADA Handrail	23

AMERICAN SERIES

BRING TIMELESS LOOKS HOME

Key-Link's top-selling aluminum railing has a clean flat-top profile for a modern yet classic style. This versatile railing complements any design and can be paired with aluminum balusters or with Key-Link's horizontal or vertical cable infill for a truly custom look.





AMERICAN SERIES

PRODUCT DETAILS

- Level and stair rail lengths come in 5', 6', 7' or 8' sections
- Available in 36" or 42" heights
- Meets IRC and IBC (42" only) code requirements
- Boxed sections include top and bottom rails, mounting brackets and hardware, infill and the installation guide

*Except Horizontal Cable

Pictured Above:

- a. Textured Black with Horizontal Cable Infill
- b. Textured White with Black Square Infill
- c. Textured Black with Vertical Cable Infill

PROFILE

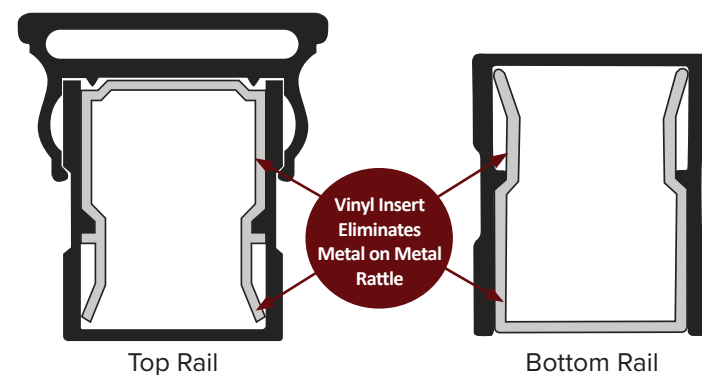

AVAILABLE COLORS



INFILL OPTIONS

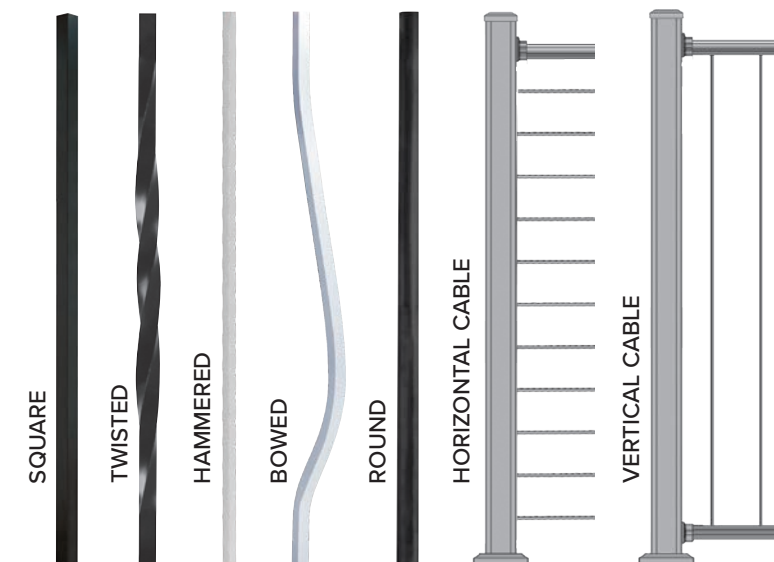

OUTLOOK SERIES

OPEN YOUR SPACE WITH STYLE

The slim-profile Outlook railing works in small or large spaces thanks to its sleek, go-anywhere design and unobtrusive footprint. Outlook's clean lines help define and open a space, providing both security and elegance to outdoor living.





OUTLOOK SERIES

PRODUCT DETAILS

- Level rail lengths come in 5', 6', 7' or 8' and stair rail lengths come in 4', 5', 6' or 8'
- Available in 36" or 42" heights
- Meets IRC and IBC (42" only) code requirements
- Boxed sections include top and bottom rails, mounting brackets and hardware, infill and the installation guide

PROFILE

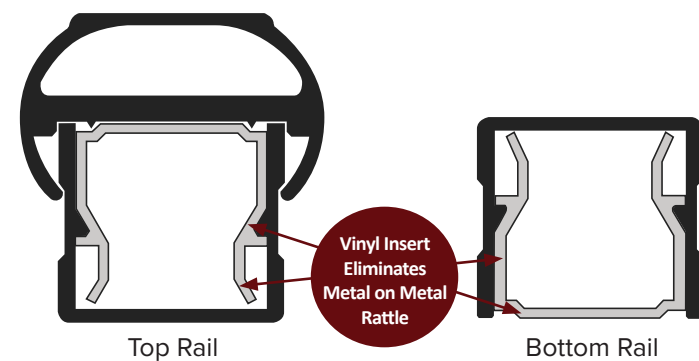

AVAILABLE COLORS

TEXTURED BLACK	TEXTURED WHITE	TEXTURED BRONZE	MATTE BLACK
MATTE WHITE	OIL-RUBBED BRONZE	GLOSS BLACK	GLOSS WHITE
GLOSS BRONZE	SILVER	KONA	GLOSS BEIGE
BROWNSTONE	REDWOOD	HUNTER GREEN	SPECKLED WALNUT

AVAILABLE INFILL

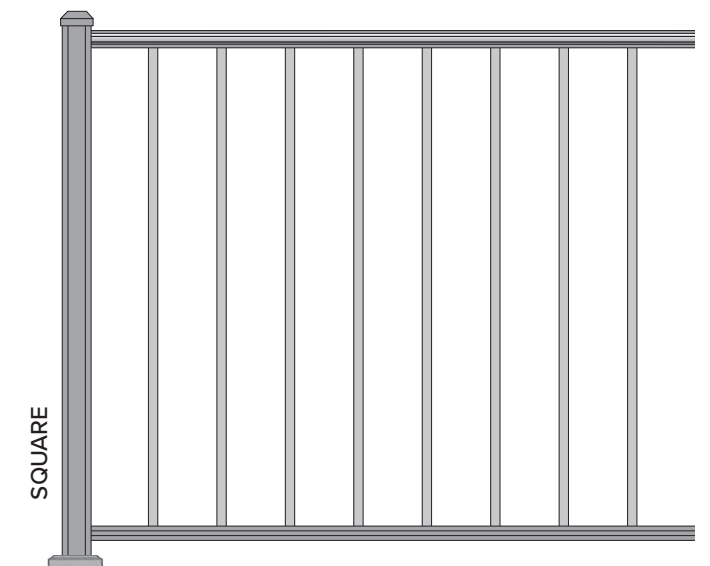

Pictured Above:

a. Matte Black with Square Infill

b. Textured White with Square Infill

c. Matte Black with Square Infill

CHESAPEAKE SERIES

ENTERTAIN WITH ELEGANCE

This well-designed drink rail brings high-end form and function to your outdoor living. You and your guests will enjoy the convenience of having a place to rest drinks and plates, while your contractor will appreciate how quickly and easily the deckboard attaches to our specially designed profile.

Chesapeake coordinates with Key-Link's American Series for those who wish to use deckboard rail and standard railing together.





CHESAPEAKE SERIES

PRODUCT DETAILS

- Level and stair rail lengths come in 6' or 8' sections
- Available in 36" or 42" heights
- Meets IRC and IBC (42" only) code requirements
- Boxed sections include top and bottom rails, mounting brackets and hardware, infill and the installation guide

*Except Horizontal Cable

Pictured Above:
 a. Textured Black with Horizontal Cable Infill
 b. Textured Bronze with Square Infill
 c. Matte Black with Square Infill

PROFILE

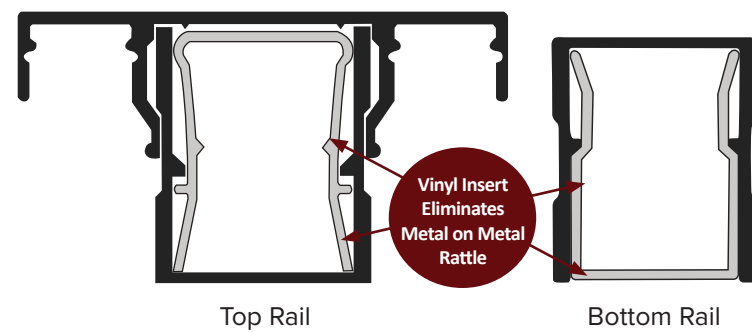

AVAILABLE COLORS

TEXTURED BLACK	TEXTURED WHITE	TEXTURED BRONZE	MATTE BLACK
MATTE WHITE	OIL-RUBBED BRONZE	GLOSS BLACK	GLOSS WHITE
GLOSS BRONZE	SILVER	KONA	GLOSS BEIGE
BROWNSTONE	REDWOOD	HUNTER GREEN	SPECKLED WALNUT

INFILL OPTIONS

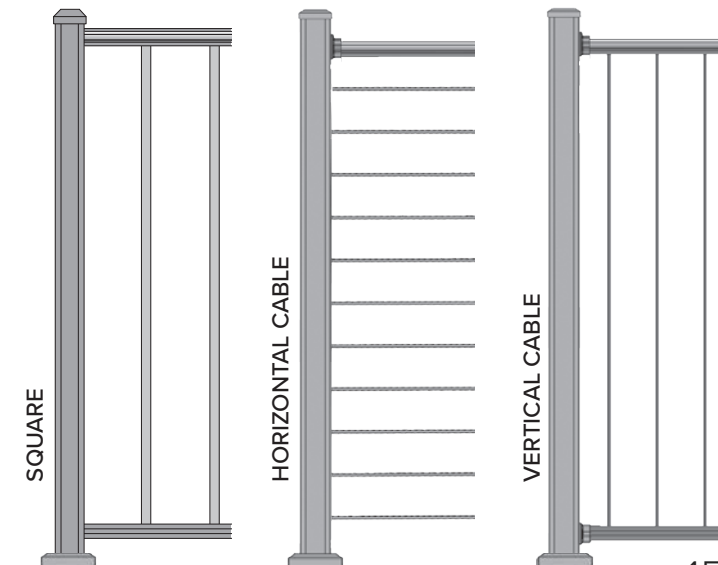



AMERICAN SERIES

OUTLOOK SERIES

CHESAPEAKE SERIES

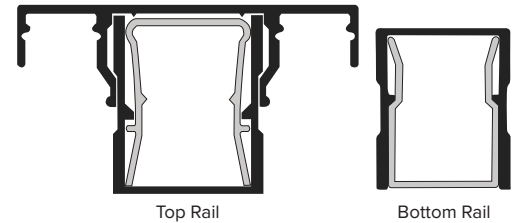
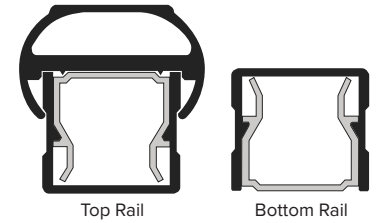
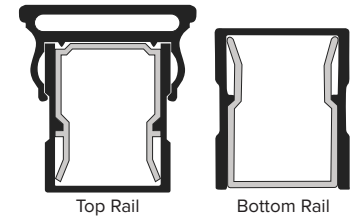

- 1 3/4" W x 1 7/8" H Flat Top Rail
- Railing Height Options: 36" - 42"
- Railing Length Options: 5' - 6' - 7' - 8'
- Square Balusters are 3/4"

- 1 1/2" W x 1 1/2" H Top Rail
- Railing Height Options: 36" - 42"
- Railing Length Options: 5' - 6' - 7' - 8'
- Square Balusters are 5/8"

- 2 7/8" x 1 1/8" Top Rail (Deckboard Not Included)
- Railing Height Options: 36" - 42"
- Railing Length Options: 6' - 8'
- Square Balusters are 3/4"

INFILL OPTIONS

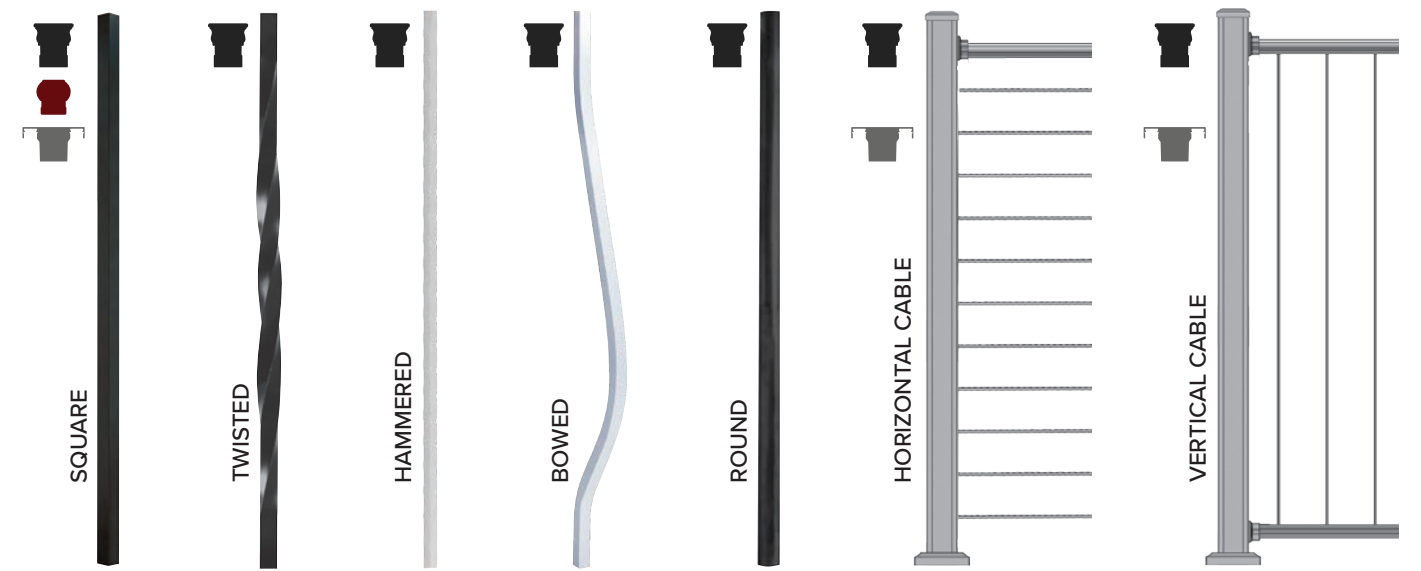

AVAILABLE COLORS



EXTERNAL CABLE FITTINGS

GIVE YOUR VIEW AN UPGRADE

Cable fittings allow you to turn wood, aluminum, composite, or masonry posts into vehicles for beautiful on-trend horizontal cable railing.

These slimmed down fittings have full tensioning capacity for safety and security and require only a few standard tools for installation.

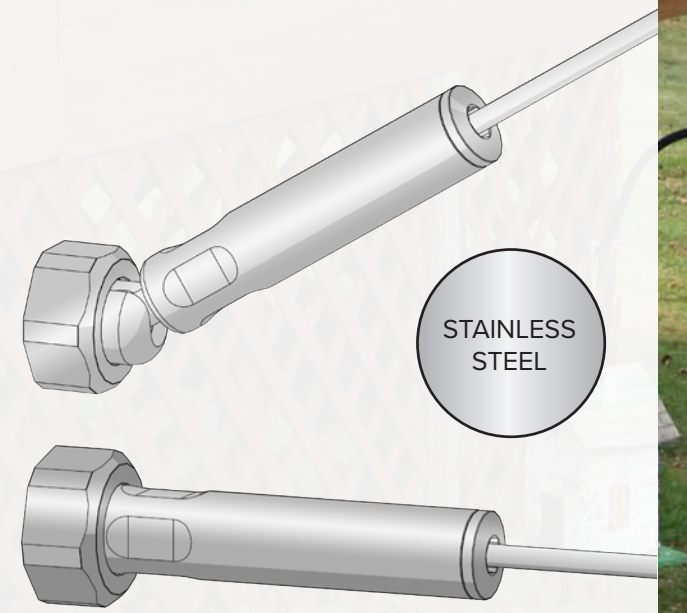

Stair and level fittings available.

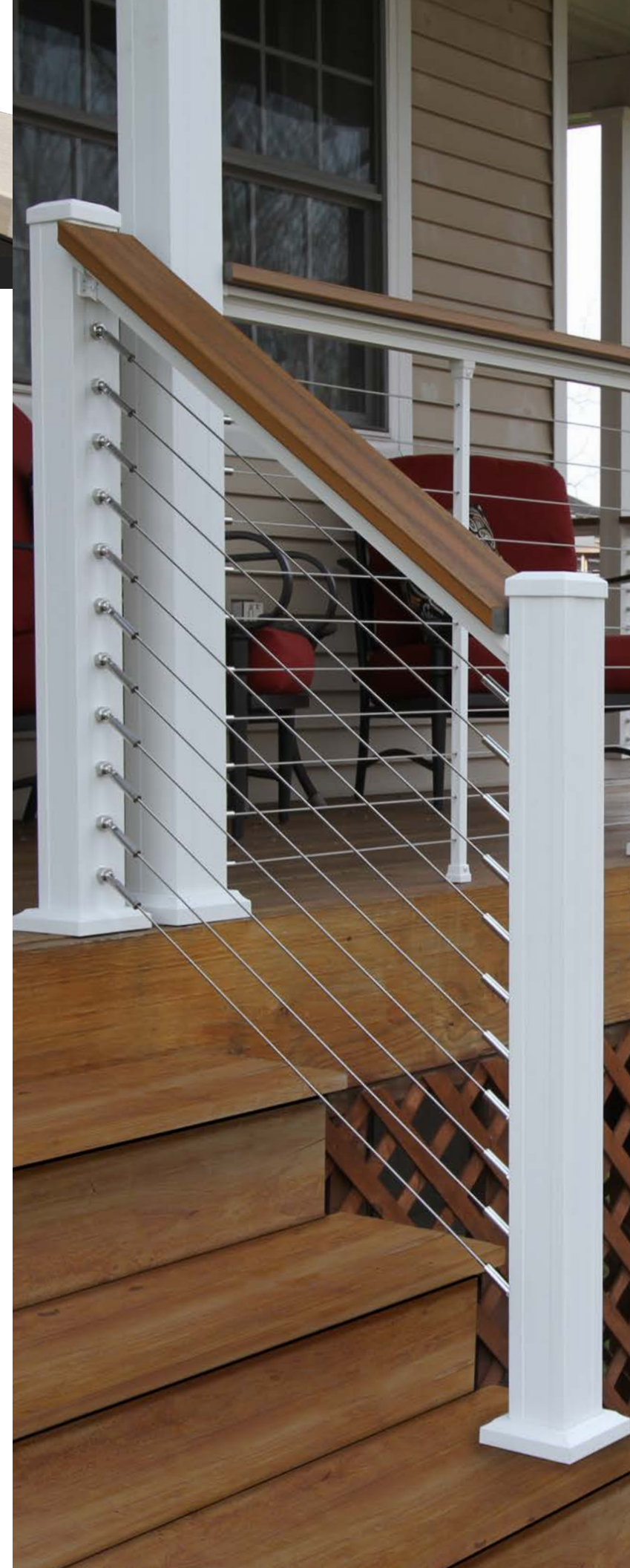

WHAT'S YOUR ANGLE?

Key-Link's brackets can help take your railing in a new direction!
 These powder coated, self-centering brackets can handle installation angles from 0-52° horizontally and 0-52° vertically, so no matter your installation challenge, Key-Link has a bracket.



OUTLOOK SERIES BRACKETS & WEDGES



CHESAPEAKE SERIES BRACKETS & WEDGES



AMERICAN SERIES BRACKETS & WEDGES



VERTICAL BRACKET ANGLE GUIDE

Find the vertical angle you need, then note the appropriate bracket.

- Universal Swivel = 0°-52°
- Vertical Swivel = 0°-30°
- Stair = 32°-36°
- Vertical Wedge = 5°-7°

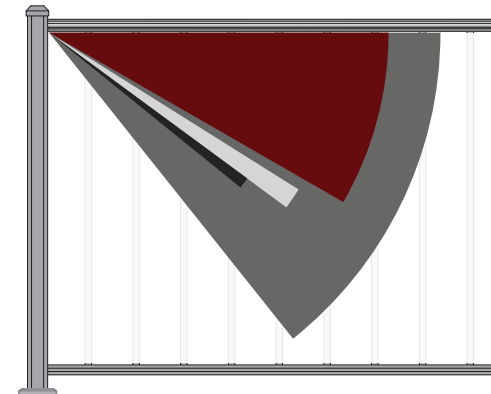

HORIZONTAL BRACKET ANGLE GUIDE

Find the horizontal angle you need, then note the appropriate bracket.

- Universal Swivel = 0°-52°
- Horizontal Swivel = 0°-40°
- 45° Bracket = 45°
- Horizontal Wedge = 5°-7°

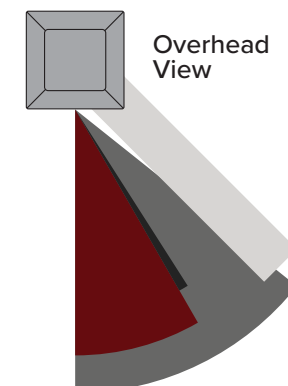



BRING YOUR SPACE TO LIGHT

Create stunning focal points and add atmosphere and safety to your outdoor living space with lighting. Key-Link's lighting is designed to pair with railing for a beautiful, seamless look. Post cap and accent lights are made from diecast aluminum and powder-coated with the same coating and color, which means both posts and lights will retain their color in the same way.

Key-Link's electrical engineers and experts have refined our lights for a long-lasting and easy-to-use system that brings exceptional outdoor lighting to your deck or porch.

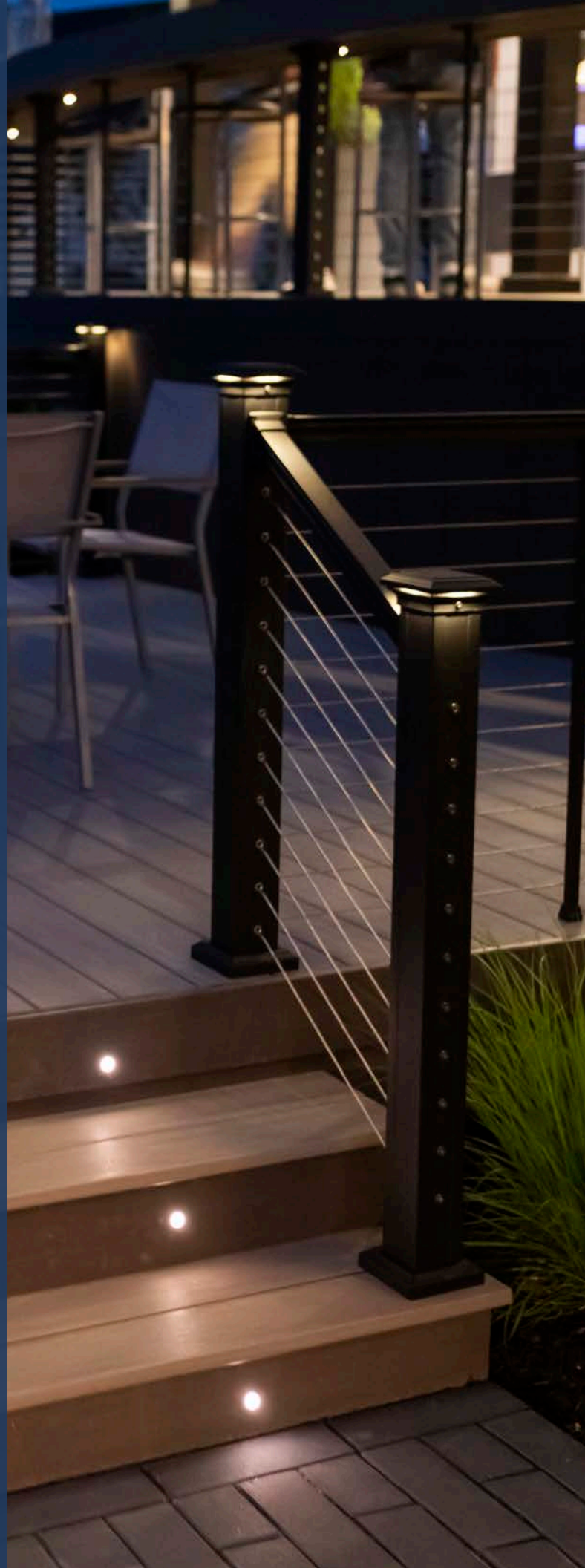

STANDARD COLORS

Powder-coated die-cast aluminum



SPECIAL ORDER COLOR OPTIONS



POST & ACCENT LIGHTS

Sizes available for 2½", 3¼" and 4" Posts

POST CAP LIGHTS

3000k LED

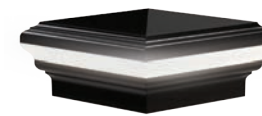

PYRAMID

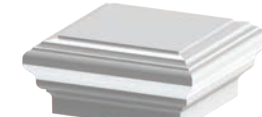

DECORATIVE

POST CAP DOWNLIGHTS

3000k LED



PYRAMID

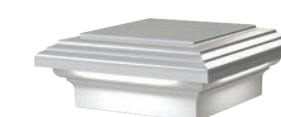

DECORATIVE

POST & STAIR ACCENT LIGHT

3000k LED



POST CAPS (NO LIGHTS)

PYRAMID



DECORATIVE

UNDER RAIL LIGHTING



Only available for Chesapeake Series

LIGHTING ACCESSORIES

LIGHTING CONTROL HUB & POWER SUPPLY



- Timer lets you choose 1-9 hours of light, or dusk-to-dawn
- Dimmer mode with 9 brightness levels
- Adjustable photocell sensor to control for ambient light
- **Walk Away** feature for safe exiting before lights go out
- Aluminum housing to match railing
- Power Supply available in 60w or Power Station

POST LIGHT WIRE KIT

- KIT INCLUDES:
- Staples
 - 2-way splitter
 - 5' and 9' wire extensions

WIRE EXTENSIONS, WIRE SPLITTERS

- WIRE EXTENSIONS:
- 2', 5', 9' Lengths Available
- WIRE SPLITTER KITS:
- 2-Way Kit: Includes (1) 8" input cable to (2) 8" output cables
 - 3-Way Kit: Includes (1) 8" input cable to (3) 10" output cables

2" POST ADAPTER

- Made to fit fence posts
- Fits 2" Posts
- Uses 2½" Cap for 2" Post



FASCIA MOUNT BRACKETS

Available for both 2½" and 3¼" posts

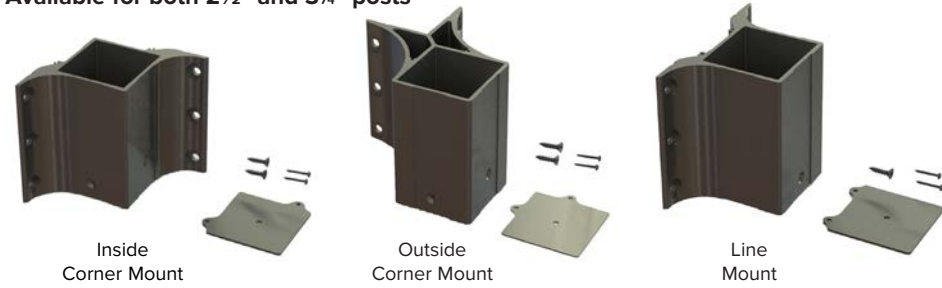

STANDARD COLORS



Special order colors also available.

POST CAPS & TRIM

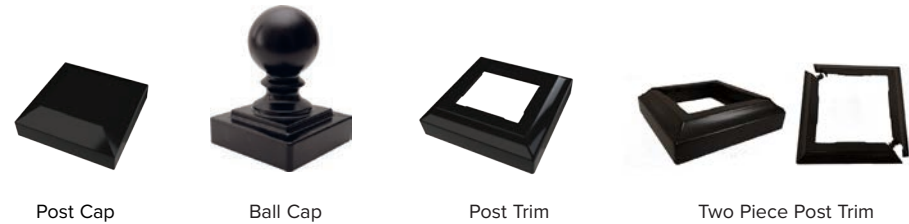

POSTS, POST WRAP

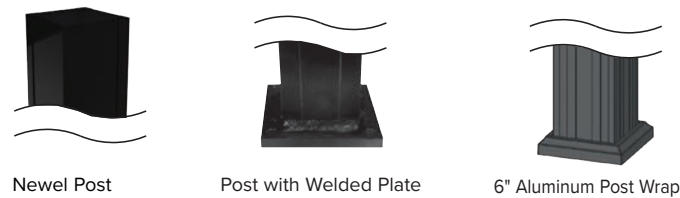

PORCH POSTS

3¼" & 4" Structural Porch Posts

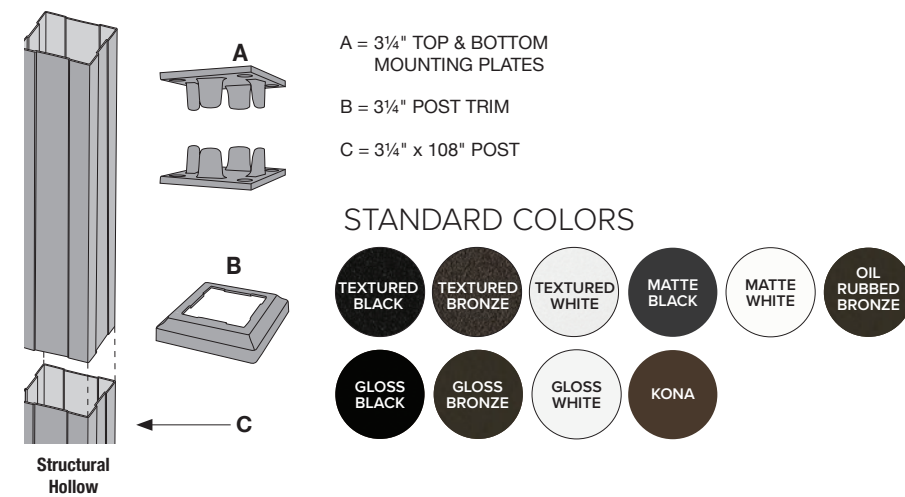

ADA ALUMINUM HANDRAIL

ADA Aluminum Handrail adds safety and security without compromising on looks! This handrail is designed to coordinate perfectly with Key-Link's existing railing for a beautiful, functional, and safe railing system.



STANDARD COLORS

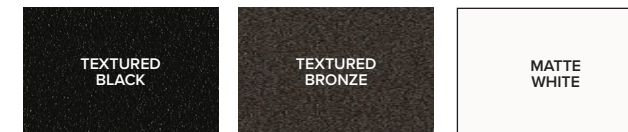

SPECIAL ORDER COLORS

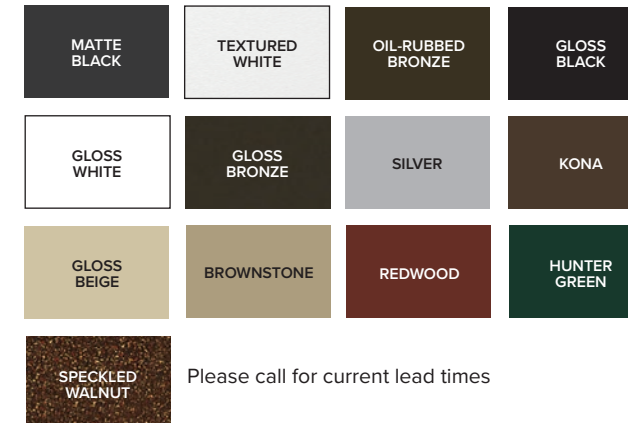

- A** END CAP
- B** P- LOOP RETURN
- C** ADA HANDRAIL BRACKET
- D** HANDRAIL CONNECTOR WITH RING
- E** 5° RADIUS ELBOW (24")
- F** 34° RADIUS ELBOW (24")
- G** STRAIGHT HANDRAIL (104")
- H** 90° RADIUS ELBOW (24")
- I** 6" CORNER MOUNTING BRACKET
- J** 0° - 90° UNIVERSAL ELBOW
- K** OUTSIDE ELBOW
- L** ALUMINUM 90° ELBOW BRACKET
- M** STRAIGHT ALUMINUM WALL BRACKET WITH RING
- N** ALUMINUM GATE RETURN (+ O)
- O** UNIVERSAL ELBOW HANDRAIL BRACKET



KEY-LINK™
FENCING & RAILING



keylinkonline.com

260 Jalyn Drive, New Holland, PA 17557

717-355-7130 // Toll Free: 888-704-7130

Fax: 717-355-7139

© 2023 Key-Link Fencing & Railing | KFRCC230223



DISTRIBUTED BY:



121 Countryside Dr. | Belleville, WI 53508
(608) 424-9080 | customcraftdist.com

Relax... You've come home to Custom Craft.

From railings to pergolas, from arbors to fencing, Custom Craft Distribution offers a wide variety of low-maintenance products and accessories to create the outdoor living spaces you want.

To learn more about Custom Craft and find complete information on our wide variety of outdoor living products, please visit us online at www.customcraftdist.com

